

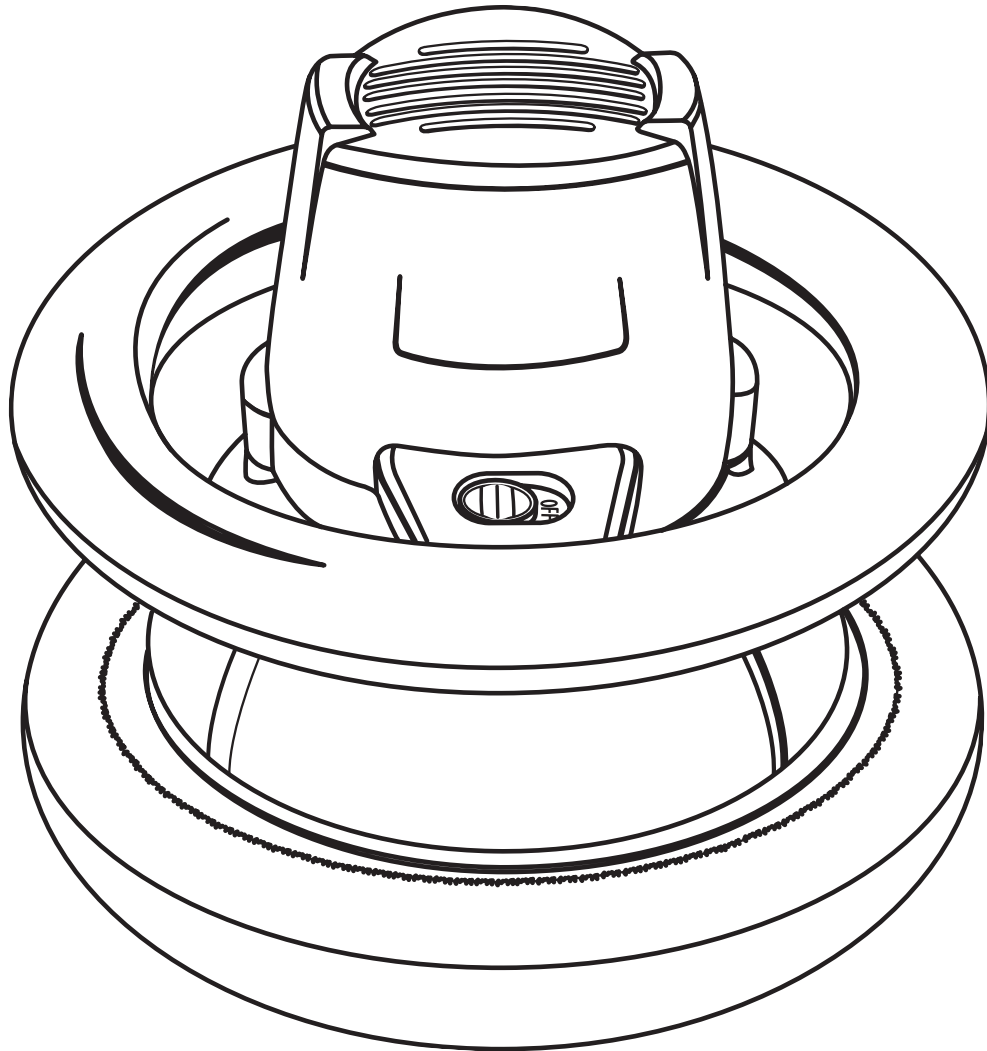

# OPERATOR'S MANUAL

## 10 in. BUFFER/POLISHER

### RB101



Your buffer/polisher has been engineered and manufactured to our high standard for dependability, ease of operation, and operator safety. When properly cared for, it will give you years of rugged, trouble-free performance.

**⚠ WARNING:** To reduce the risk of injury, the user must read and understand the operator's manual before using this product.

Thank you for your purchase.

**SAVE THIS MANUAL FOR FUTURE REFERENCE**

# TABLE OF CONTENTS

■ Introduction .....	2
■ Warranty .....	2
■ General Safety Rules .....	3-4
■ Specific Safety Rules.....	4
■ Symbols.....	5-6
■ Electrical .....	7
■ Features.....	8
■ Assembly .....	9
■ Operation.....	9-11
■ Maintenance.....	12
■ Troubleshooting .....	13
■ Parts Ordering / Service .....	14

## INTRODUCTION

This tool has many features for making its use more pleasant and enjoyable. Safety, performance, and dependability have been given top priority in the design of this product making it easy to maintain and operate.

## WARRANTY

### **RYOBI® POWER TOOL - LIMITED TWO YEAR WARRANTY AND 30 DAY EXCHANGE POLICY**

One World Technologies, Inc., warrants its RYOBI® power tools with the following conditions:

**30-DAY EXCHANGE POLICY:** During the first 30 days after date of purchase, you may either request service under this warranty or you may exchange any RYOBI® power tool which does not work properly due to defective workmanship or materials by returning the power tool to the dealer from which it was purchased. To receive a replacement power tool or requested warranty service, you must present proof of purchase and return all original equipment packaged with the original product. The replacement power tool will be covered by the limited warranty for the balance of the two year period from the date of the original purchase.

**WHAT THIS WARRANTY COVERS:** This warranty covers all defects in workmanship or materials in your RYOBI® power tool for a period of two years from the date of purchase. With the exception of batteries, power tool accessories are warranted for ninety (90) days. Batteries are warranted for two years.

**HOW TO GET SERVICE:** Just return the power tool, properly packaged and postage prepaid, to an Authorized Service Center. You can obtain the location of the Service Center nearest you by contacting a service representative at One World Technologies, Inc., P.O. Box 1207, Anderson, SC 29622-1207, by calling 1-800-525-2579 or by logging on to [www.ryobitools.com](http://www.ryobitools.com). When you request warranty service, you must also present proof of purchase documentation, which includes the date of purchase (for example, a bill of sale). We will repair any faulty workmanship, and either repair or replace any defective part, at our option. We will do so without any charge to you. We will complete the work in a reasonable time, but, in any case, within ninety (90) days or less.

**WHAT'S NOT COVERED:** This warranty applies only to the original purchaser at retail and may not be transferred. This warranty only covers defects arising under normal usage and does not cover any malfunction, failure or defects resulting from misuse, abuse, neglect, alteration, modification or repairs by other than Authorized Service Centers. One World Technologies, Inc. makes no warranties, representations or promises as to the quality or performance of its power tools other than those specifically stated in this warranty.

**ADDITIONAL LIMITATIONS:** Any implied warranties granted under state law, including warranties of merchantability or fitness for a particular purpose, are limited to two years from the date of purchase. One World Technologies, Inc. is not responsible for direct, indirect, or incidental damages, so the above limitations and exclusions may not apply to you. This warranty gives you specific legal rights, and you may also have other rights which vary from state to state.

# GENERAL SAFETY RULES



## WARNING:

Read and understand all instructions. Failure to follow all instructions listed below, may result in electric shock, fire and/or serious personal injury.

## SAVE THESE INSTRUCTIONS

### WORK AREA

- **Keep your work area clean and well lit.** Cluttered benches and dark areas invite accidents.
- **Do not operate power tools in explosive atmospheres, such as in the presence of flammable liquids, gases, or dust.** Power tools create sparks which may ignite the dust or fumes.
- **Keep bystanders, children, and visitors away while operating a power tool.** Distractions can cause you to lose control.

### ELECTRICAL SAFETY

- **Double insulated tools are equipped with a polarized plug (one blade is wider than the other). This plug will fit in a polarized outlet only one way. If the plug does not fit fully in the outlet, reverse the plug. If it still does not fit, contact a qualified electrician to install a polarized outlet. Do not change the plug in any way.** Double insulation  eliminates the need for the three-wire grounded power cord and grounded power supply system.
- **Avoid body contact with grounded surfaces such as pipes, radiators, ranges, and refrigerators.** There is an increased risk of electric shock if your body is grounded.
- **Don't expose power tools to rain or wet conditions.** Water entering a power tool will increase the risk of electric shock.
- **Do not abuse the cord. Never use the cord to carry the tools or pull the plug from an outlet. Keep cord away from heat, oil, sharp edges, or moving parts. Replace damaged cords immediately.** Damaged cords increase the risk of electric shock.
- **When operating a power tool outside, use an outdoor extension cord marked "W-A" or "W".** These cords are rated for outdoor use and reduce the risk of electric shock.

### PERSONAL SAFETY

- **Stay alert, watch what you are doing and use common sense when operating a power tool. Do not use tool while tired or under the influence of drugs, alcohol, or medication.** A moment of inattention while operating power tools may result in serious personal injury.
- **Dress properly. Do not wear loose clothing or jewelry. Contain long hair. Keep your hair, clothing, and gloves away from moving parts.** Loose clothes, jewelry, or long hair can be caught in moving parts.

- **Avoid accidental starting. Be sure switch is off before plugging in.** Carrying tools with your finger on the switch or plugging in tools that have the switch on invites accidents.
- **Remove adjusting keys or wrenches before turning the tool on.** A wrench or a key that is left attached to a rotating part of the tool may result in personal injury.
- **Do not overreach. Keep proper footing and balance at all times.** Proper footing and balance enables better control of the tool in unexpected situations.
- **Use safety equipment. Always wear eye protection.** Dust mask, nonskid safety shoes, hard hat, or hearing protection must be used for appropriate conditions.
- **Do not wear loose clothing or jewelry. Contain long hair.** Loose clothes, jewelry, or long hair can be drawn into air vents.
- **Do not use on a ladder or unstable support.** Stable footing on a solid surface enables better control of the tool in unexpected situations.

### TOOL USE AND CARE

- **Use clamps or other practical way to secure and support the workpiece to a stable platform.** Holding the work by hand or against your body is unstable and may lead to loss of control.
- **Do not force tool. Use the correct tool for your application.** The correct tool will do the job better and safer at the rate for which it is designed.
- **Do not use tool if switch does not turn it on or off.** Any tool that cannot be controlled with the switch is dangerous and must be repaired.
- **Disconnect the plug from power source before making any adjustments, changing accessories, or storing the tool.** Such preventive safety measures reduce the risk of starting the tool accidentally.
- **Store idle tools out of the reach of children and other untrained persons.** Tools are dangerous in the hands of untrained users.
- **Maintain tools with care. Keep cutting tools sharp and clean.** Properly maintained tools with sharp cutting edges are less likely to bind and are easier to control.
- **Check for misalignment or binding of moving parts, breakage of parts, and any other condition that may affect the tool's operation. If damaged, have the tool serviced before using.** Many accidents are caused by poorly maintained tools.
- **Use only accessories that are recommended by the manufacturer for your model.** Accessories that may be suitable for one tool, may become hazardous when used on another tool.
- **Keep the tool and its handle dry, clean and free from oil and grease. Always use a clean cloth when cleaning. Never use brake fluids, gasoline, petroleum-based products, or any strong solvents to clean your tool. Following this rule will reduce the risk of loss of control and deterioration of the enclosure plastic.**

# GENERAL SAFETY RULES

## SERVICE











- **Tool service must be performed only by qualified repair personnel.** Service or maintenance performed by unqualified personnel may result in a risk of injury.
- **When servicing a tool, use only identical replacement parts. Follow instructions in the Maintenance section of this manual.** Use of unauthorized parts or failure to follow Maintenance Instructions may create a risk of shock or injury.

# SPECIFIC SAFETY RULES

- **Hold tool by insulated gripping surfaces when performing an operation where the cutting tool may contact hidden wiring or its own cord.** Contact with a “live” wire will make exposed metal parts of the cutting tool “live” and shock the operator.
- **Know your power tool. Read operator’s manual carefully. Learn its applications and limitations, as well as the specific potential hazards related to this tool.** Following this rule will reduce the risk of electric shock, fire, or serious injury.
- **Always wear safety glasses. Everyday eyeglasses have only impact-resistant lenses; they are NOT safety glasses.** Following this rule will reduce the risk of serious personal injury.
- **Protect your lungs. Wear a face or dust mask if the operation is dusty.** Following this rule will reduce the risk of serious personal injury.
- **Protect your hearing. Wear hearing protection during extended periods of operation.** Following this rule will reduce the risk of serious personal injury.
- **Inspect tool cords periodically and, if damaged, have repaired at your nearest Authorized Service Center. Constantly stay aware of cord location.** Following this rule will reduce the risk of electric shock or fire.
- **Check damaged parts. Before further use of the tool, a guard or other part that is damaged should be carefully checked to determine that it will operate properly and perform its intended function. Check for alignment of moving parts, binding of moving parts, breakage of parts, mounting, and any other conditions that may affect its operation. A guard or other part that is damaged should be properly repaired or replaced by an authorized service center.** Following this rule will reduce the risk of shock, fire, or serious injury.
- **Make sure your extension cord is in good condition. When using an extension cord, be sure to use one heavy enough to carry the current your product will draw. A wire gauge size (A.W.G.) of at least 16 is recommended for an extension cord 50 feet or less in length. A cord exceeding 100 feet is not recommended. If in doubt, use the next heavier gauge. The smaller the gauge number, the heavier the cord. An undersized cord will cause a drop in line voltage resulting in loss of power and overheating.**
- **Inspect for and remove all nails from lumber before using this tool.** Following this rule will reduce the risk of serious personal injury.
- **If the power supply cord is damaged,** it must be replaced only by the manufacturer or by an authorized service center to avoid risk.
- **Save these instructions.** Refer to them frequently and use them to instruct others who may use this tool. If you loan someone this tool, loan them these instructions also.



# SYMBOLS

Some of the following symbols may be used on this tool. Please study them and learn their meaning. Proper interpretation of these symbols will allow you to operate the tool better and safer.

SYMBOL	NAME	DESIGNATION/EXPLANATION
V	Volts	Voltage
A	Amperes	Current
Hz	Hertz	Frequency (cycles per second)
W	Watt	Power
min	Minutes	Time
~	Alternating Current	Type of current
≡	Direct Current	Type or a characteristic of current
$n_0$	No Load Speed	Rotational speed, at no load
	Class II Construction	Double-insulated construction
.../min	Per Minute	Revolutions, strokes, surface speed, orbits etc., per minute
	Wet Conditions Alert	Do not expose to rain or use in damp locations.
	Read The Operator's Manual	To reduce the risk of injury, user must read and understand operator's manual before using this product.
	Eye Protection	Always wear safety goggles or safety glasses with side shields and, as necessary, a full face shield when operating this product.
	Safety Alert	Precautions that involve your safety.
	No Hands Symbol	Failure to keep your hands away from the blade will result in serious personal injury.
	No Hands Symbol	Failure to keep your hands away from the blade will result in serious personal injury.
	No Hands Symbol	Failure to keep your hands away from the blade will result in serious personal injury.
	No Hands Symbol	Failure to keep your hands away from the blade will result in serious personal injury.
	Hot Surface	To reduce the risk of injury or damage, avoid contact with any hot surface.

# SYMBOLS

The following signal words and meanings are intended to explain the levels of risk associated with this product.

SYMBOL	SIGNAL	MEANING
	<b>DANGER:</b>	Indicates an imminently hazardous situation, which, if not avoided, will result in death or serious injury.
	<b>WARNING:</b>	Indicates a potentially hazardous situation, which, if not avoided, could result in death or serious injury.
	<b>CAUTION</b>	Indicates a potentially hazardous situation, which, if not avoided, may result in minor or moderate injury.
	<b>CAUTION</b>	(Without Safety Alert Symbol) Indicates a situation that may result in property damage.

## SERVICE

Servicing requires extreme care and knowledge and should be performed only by a qualified service technician. For service we suggest you return the product to the nearest **AUTHORIZED SERVICE CENTER** for repair. When servicing, use only identical replacement parts.



### **WARNING:**

To avoid serious personal injury, do not attempt to use this product until you read thoroughly and understand completely the operator's manual. If you do not understand the warnings and instructions in the operator's manual, do not use this product. Call Ryobi customer service for assistance.



### **WARNING:**



The operation of any power tool can result in foreign objects being thrown into your eyes, which can result in severe eye damage. Before beginning power tool operation, always wear safety goggles or safety glasses with side shields and, when needed, a full face shield. We recommend Wide Vision Safety Mask for use over eyeglasses or standard safety glasses with side shields. Always use eye protection which is marked to comply with ANSI Z87.1.

## SAVE THESE INSTRUCTIONS

# ELECTRICAL

## DOUBLE INSULATION

Double insulation is a concept in safety in electric power tools, which eliminates the need for the usual three-wire grounded power cord. All exposed metal parts are isolated from the internal metal motor components with protecting insulation. Double insulated tools do not need to be grounded.

### **WARNING:**

The double insulated system is intended to protect the user from shock resulting from a break in the tool's internal insulation. Observe all normal safety precautions to avoid electrical shock.

**NOTE:** Servicing of a tool with double insulation requires extreme care and knowledge of the system and should be performed only by a qualified service technician. For service, we suggest you return the tool to your nearest authorized service center for repair. Always use original factory replacement parts when servicing.

## ELECTRICAL CONNECTION

This tool has a precision-built electric motor. It should be connected to a **power supply that is 120 volts, 60 Hz, AC only (normal household current)**. Do not operate this tool on direct current (DC). A substantial voltage drop will cause a loss of power and the motor will overheat. If the tool does not operate when plugged into an outlet, double-check the power supply.

## EXTENSION CORDS

When using a power tool at a considerable distance from a power source, be sure to use an extension cord that has the capacity to handle the current the tool will draw. An undersized cord will cause a drop in line voltage, resulting in overheating and loss of power. Use the chart to determine the minimum wire size required in an extension cord. Only round jacketed cords listed by Underwriter's Laboratories (UL) should be used.

When working outdoors with a tool, use an extension cord that is designed for outside use. This type of cord is designated with "WA" on the cord's jacket.

Before using any extension cord, inspect it for loose or exposed wires and cut or worn insulation.

\*\*Ampere rating (on tool data plate)

Cord Length	Wire Size (A.W.G.)					
	0-2.0	2.1-3.4	3.5-5.0	5.1-7.0	7.1-12.0	12.1-16.0
25'	16	16	16	16	14	14
50'	16	16	16	14	14	12
100'	16	16	14	12	10	—

\*\*Used on 12 gauge - 20 amp circuit.

**NOTE:** AWG = American Wire Gauge

### **WARNING:**

Keep the extension cord clear of the working area. Position the cord so that it will not get caught on lumber, tools or other obstructions while you are working with a power tool. Failure to do so can result in serious personal injury.

### **WARNING:**

Check extension cords before each use. If damaged replace immediately. Never use tool with a damaged cord since touching the damaged area could cause electrical shock resulting in serious injury.

# FEATURES

## PRODUCT SPECIFICATIONS

Orbit Diameter ..... 1/2 in.  
Motion ..... Random Orbital

Orbits per minute ..... 3 200 r/min. (RPM)  
Input ..... 120 V, 60 Hz, AC only, .75 A

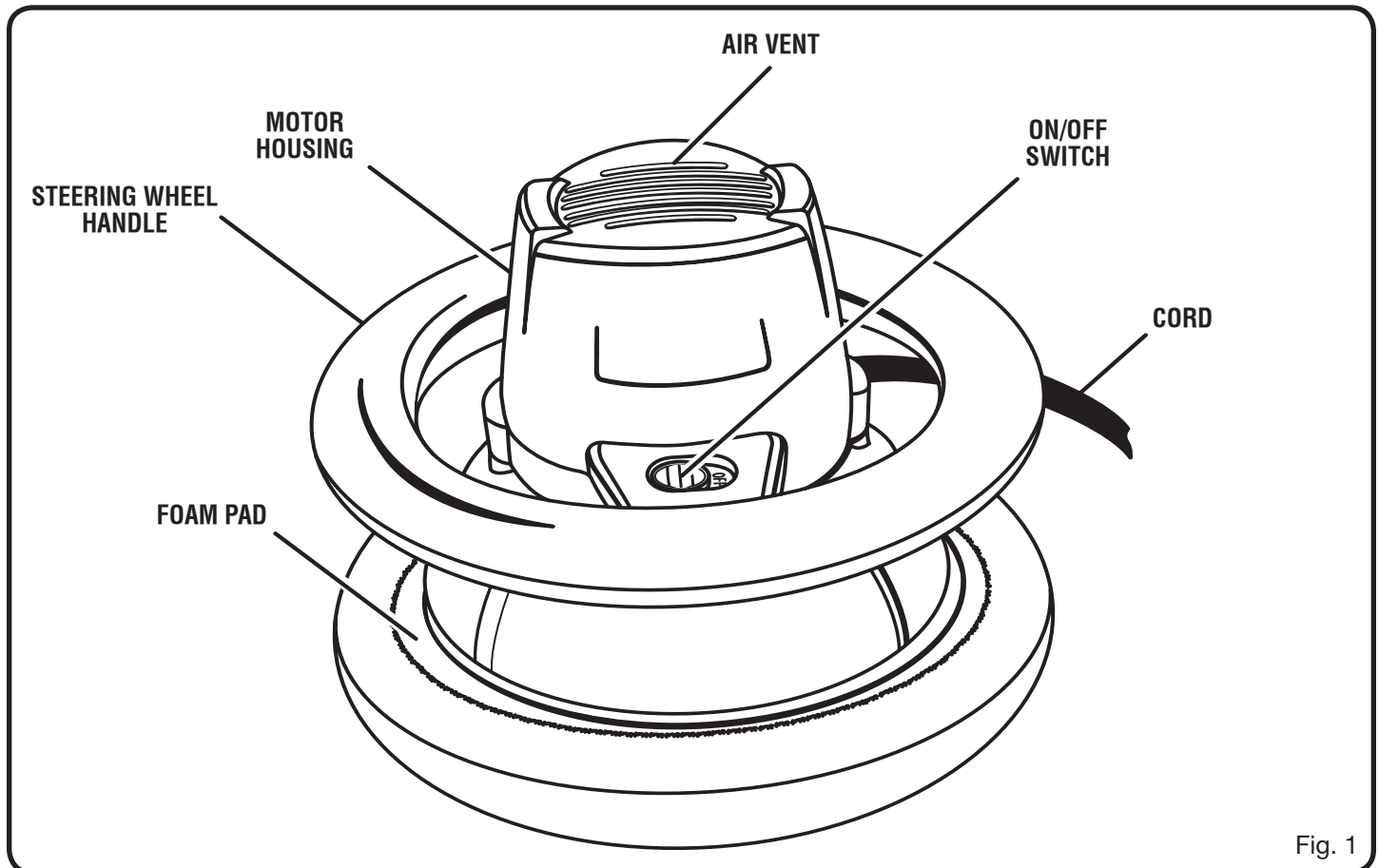

Fig. 1

## KNOW YOUR BUFFER/POLISHER

See Figure 1.

The safe use of this product requires an understanding of the information on the tool and in this operator's manual as well as a knowledge of the project you are attempting. Before use of this product, familiarize yourself with all operating features and safety rules.

## APPLICATION BONNET

The reusable application bonnet is made of 100% terry cloth.

## CORD

The buffer/polisher has a 6-foot power cord.

## FOAM PAD

The foam pad is 10 in. in diameter.

## MOTOR HOUSING

The air vent for the motor is located on top of the motor housing.

## ON/OFF SWITCH

The ON/OFF switch is within reach of the operator's thumb.

## POLISHING BONNET

The reusable polishing bonnet is made of synthetic tufted material.

## STEERING WHEEL HANDLE

The buffer/polisher has a steering wheel-shaped handle.

# ASSEMBLY

## UNPACKING

This product has been shipped completely assembled.

- Carefully remove the tool and any accessories from the box. Make sure that all items listed in the packing list are included.
- Inspect the tool carefully to make sure no breakage or damage occurred during shipping.
- Do not discard the packing material until you have carefully inspected and satisfactorily operated the tool.
- If any parts are damaged or missing, please call 1-800-525-2579 for assistance.

## PACKING LIST

10 in. Buffer/Polisher

Application Bonnet

Polishing Bonnet

Operator's Manual

### **WARNING:**

If any parts are damaged or missing do not operate this tool until the parts are replaced. Failure to heed this warning could result in serious personal injury.

### **WARNING:**

Do not attempt to modify this tool or create accessories not recommended for use with this tool. Any such alteration or modification is misuse and could result in a hazardous condition leading to possible serious personal injury.

### **WARNING:**

Do not connect to power supply until assembly is complete. Failure to comply could result in accidental starting and possible serious personal injury.

# OPERATION

### **WARNING:**

Do not allow familiarity with tools to make you careless. Remember that a careless fraction of a second is sufficient to inflict serious injury.

### **WARNING:**

Always wear safety goggles or safety glasses with side shields when operating power tools. Failure to do so could result in objects being thrown into your eyes resulting in possible serious injury.

### **WARNING:**

Do not use any attachments or accessories not recommended by the manufacturer of this tool. The use of attachments or accessories not recommended can result in serious personal injury.

## APPLICATIONS

You may use this tool for the purpose listed below:

- Buffing/polishing cars, boats, RVs, personal aircraft, motorcycles, hardwood floors, and large furniture

## PREPARE THE SURFACE

For best results, the surface should be clean and dry. Most high-gloss surfaces can be cleaned with a mild soap and water solution. For removal of stubborn dirt such as road tar, grease, and bug stains, you can use a mild ammonia solution such as that used in glass cleaners. Before using any cleaning product, check the label for recommended applications and follow the directions for use.

Never apply cleaner directly onto surface to be polished. Apply to a clean cloth then use the cloth to clean the surface.

Do not use any type of abrasive cleanser as it may damage or scratch the surface.

# OPERATION

## **⚠ WARNING:**

Before connecting the buffer/polisher to the power source, always check to make sure the switch is not in **ON** position. Failure to do so could result in accidental starting of the buffer/polisher resulting in possible serious personal injury.

## **ATTACH THE APPLICATION BONNET**

See Figure 2.

## **⚠ WARNING:**

To avoid injury, always make sure the buffer/polisher is unplugged before attaching bonnets.

The buffer/polisher comes with two bonnets, one for applying the polish to the surface and another for buffing the surface. Both are fitted with a drawstring. The application bonnet is the one made of 100% terry cloth.

### **To attach the application bonnet to the pad:**

- Loosen the drawstring so that the bonnet fits completely over the pad.
- Place the bonnet over the pad so that the outer edge can be drawn over the top of the pad.
- Carefully tighten the drawstring around the pad and secure it with a bow knot.
- Tuck the drawstring inside the bonnet.

## **⚠ WARNING:**

The drawstring must be tucked securely inside the bonnet before turning the buffer/polisher on. Failure to do so could result in the drawstring being caught between the motor housing and orbiting foam pad, increasing the risk of serious personal injury.

## **APPLY POLISH TO THE APPLICATION BONNET**

Most polishes are either in paste or liquid form. Before using any polish read all directions on appropriate applications and proper use.

### **APPLICATION OF PASTE POLISH**

See Figure 3.

Use a putty knife or other flat, blunt object to apply approximately one rounded teaspoon of paste onto the bonnet. Evenly spread the paste over the entire surface of the bonnet.

**NOTE:** Be careful not to use too much polish at one time. If the pad becomes saturated, it will not last as long.

Do not apply paste directly to the surface being polished.

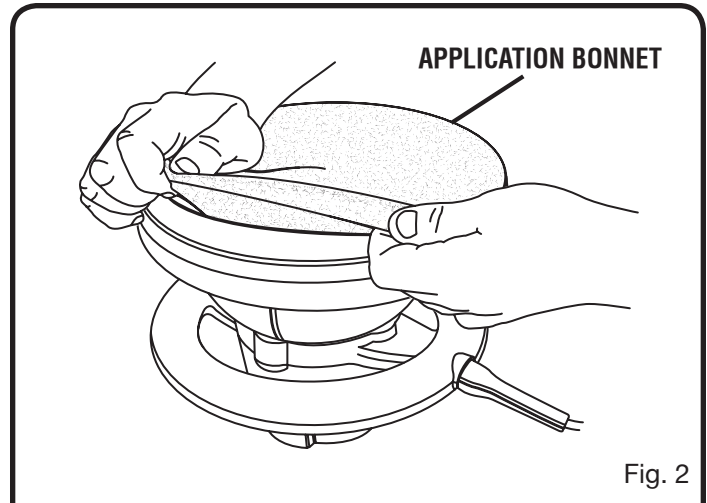

Fig. 2

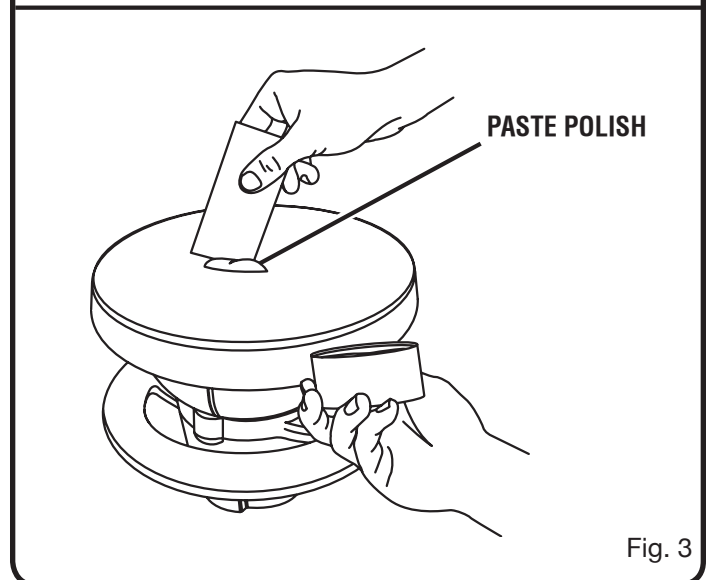

Fig. 3

# OPERATION

## APPLICATION OF LIQUID POLISH

See Figure 4.

Apply a small circle of liquid (about the size of a half-dollar) around the center of the bonnet, followed by two more rings, each slightly larger than the previous one. After the first application, the bonnet will not absorb as much polish. Apply two rings of polish to the bonnet for subsequent applications, using half of the initial quantity.

**NOTE:** Be careful not to use too much polish at one time. If the pad becomes saturated, it will not last as long.

## APPLY POLISH TO SURFACE

See Figure 5.

While holding the polisher firmly against the surface, slide the ON/OFF switch to the **ON** position with your thumb. Always start and stop the polisher on or against the surface being polished.

Begin by polishing larger flat surfaces, such as the hood, trunk, and roof. Use a broad sweeping motion in a criss-cross pattern. Do not press down on the surface with the polisher. Let the orbital action of the pad and bonnet do the work.

Once flat surfaces have been covered, polish curved surfaces such as car doors and quarter panels. Use small circular motions. Grip polisher with your hands at 3 and 9 o'clock so that the cord hangs free.

After applying polish to the entire surface, turn polisher off by pushing the ON/OFF switch with your thumb. Wait until the pad stops rotating before lifting the polisher from the surface. Unplug polisher.

For hard to reach areas, such as the underside of bumpers or side mirrors, apply polish by hand.

## CHANGE TO BUFFING BONNET

See Figure 6.

Remove the application bonnet by loosening the drawstring and slipping the bonnet off the pad. Replace with buffing bonnet, attaching it the same way as the application bonnet.

Buff the surface in the same order as it was polished, starting with large flat surfaces and ending with hard-to-reach areas. Use the same motion as for polishing, a broad sweeping criss-cross pattern on large flat areas and small circular motions on all other areas. Remember to let the tool do the work.

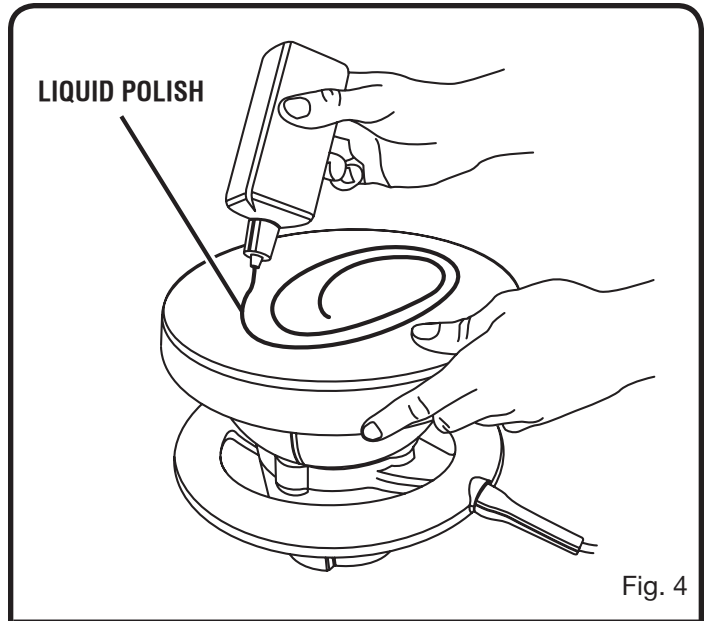

Fig. 4



Fig. 5

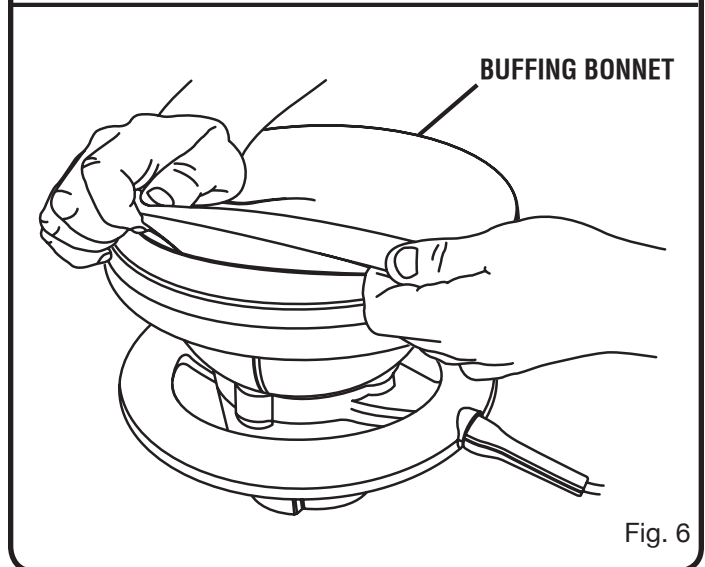

Fig. 6

# MAINTENANCE

## **WARNING:**

When servicing, use only identical replacement parts. Use of any other parts may create a hazard or cause product damage.

## **WARNING:**

Always wear safety goggles or safety glasses with side shields during power tool operation or when blowing dust. If operation is dusty, also wear a dust mask.

## GENERAL MAINTENANCE

Avoid using solvents when cleaning plastic parts. Most plastics are susceptible to damage from various types of commercial solvents and may be damaged by their use. Use clean cloths to remove dirt, dust, oil, grease, etc.

## **WARNING:**

Do not at any time let brake fluids, gasoline, petroleum-based products, penetrating oils, etc., come in contact with plastic parts. Chemicals can damage, weaken or destroy plastic which may result in serious personal injury.

Electric tools used on fiberglass material, wallboard, spackling compounds, or plaster are subject to accelerated wear and possible premature failure because the fiberglass chips and grindings are highly abrasive to bearings, brushes, commutators, etc. Consequently, we do not recommend using this tool for extended work on these types of materials. However, if you do work with any of these materials, it is extremely important to clean the tool using compressed air.

## LUBRICATION

All of the bearings in this tool are lubricated with a sufficient amount of high grade lubricant for the life of the unit under normal operating conditions. Therefore, no further lubrication is required.

## APPLICATION AND BUFFING BONNETS

Both the application and buffing bonnets are reusable. For maximum life and performance, hand wash after use and allow them to air dry. If needed, the bonnets can be machine washed in cold water with a small amount of detergent, then machine dried using low heat.

## FOAM PAD

It is important that the pad retains its original shape and dimensions. Allow it to dry completely after each use. Make sure to remove the bonnets, wash them, and store separately. Polisher should be stored with the pad facing up in order to extend pad life and retain its shape. Be careful not to use too much polish at one time. If the pad becomes saturated, it will not last as long.

## MOTOR AND INTERNAL COMPONENTS

The motor and internal components are designed to be maintenance free. The exterior surface can be cleaned with a mild soap and damp sponge.

If you suspect a problem with the motor or other internal components, do not attempt to remove the motor housing or otherwise expose the internal components. Call 1-800-525-2579 for the authorized service center nearest you.

# TROUBLESHOOTING

Problem	Possible Cause	Solution
Wax does not go on evenly	Too much wax on the bonnet	Remove a portion of the wax and retry.
Polishing seems difficult	Bonnet may be worn	Replace bonnet.
Polisher does not turn on	Bad connection to receptacle  Problem with motor	Check to make sure plug is properly seated in outlet. If using an extension cord, check connection and wire gauge.  Call your authorized service center.
Bonnet surface is creased or wrinkled, resulting in uneven application/buffing	Drawstring is loose	Untie drawstring and retighten.
Pad spins slower than normal or not at all	Motor needs to be serviced or replaced	Call your authorized service center.



# OPERATOR'S MANUAL

## 10 in. BUFFER/POLISHER

### RB101

#### **WARNING:**

Some dust created by power sanding, sawing, grinding, drilling, and other construction activities contains chemicals known to cause cancer, birth defects or other reproductive harm. Some examples of these chemicals are:

- lead from lead-based paints,
- crystalline silica from bricks and cement and other masonry products, and
- arsenic and chromium from chemically-treated lumber.

Your risk from these exposures varies, depending on how often you do this type of work. To reduce your exposure to these chemicals: work in a well ventilated area, and work with approved safety equipment, such as those dust masks that are specially designed to filter out microscopic particles.

#### • **SERVICE**

Now that you have purchased your tool, should a need ever exist for repair parts or service, simply contact your nearest Authorized Service Center. Be sure to provide all pertinent facts when you call or visit. Please call 1-800-525-2579 for your nearest Authorized Service Center. You can also check our web site at [www.ryobitools.com](http://www.ryobitools.com) for a complete list of Authorized Service Centers.

#### • **MODEL NO. AND SERIAL NO.**

The model number of this tool will be found on a plate attached to the motor housing. Please record the model number and serial number in the space provided below.

#### • **HOW TO ORDER REPAIR PARTS**

When ordering repair parts, always give the following information:

- MODEL NUMBER      RB101
- SERIAL NUMBER      \_\_\_\_\_

Ryobi® is a registered trademark of Ryobi Limited used under license.

### **ONE WORLD TECHNOLOGIES, INC.**

1428 Pearman Dairy Road, Anderson, SC 29625

Phone 1-800-525-2579

[www.ryobitools.com](http://www.ryobitools.com)